



# INSTRUCTION MANUAL

**PT5200**

FM HANDHELD TRANSCEIVER

**NOTE**

---

---

---

---

---

---

---

---

---

---

---

---

---

---

---

---

---

---

---

---

167W06000214

**INSTRUCTION MANUAL****PT5200**

FM HANDHELD TRANSCEIVER

We are very grateful for your purchasing  brand two-way radios produced by Kirisun Communication Co., Ltd.

We believe  two-way radio, which always incorporates the latest technology, can bring great convenience to your life and work;

we also believe that the quality and function of  two-way radio can meet your demands for reliable communication.

**Notice to the User**

Before using this radio, read this operating instruction carefully for safe and convenient usage. When you begin to use it, we deem that you have read this manual.

Keep this manual in a safe place and make it available to other operators in case the product is passed on to other people.

When purchasing our product, please fill in the WARRANTY CARD with truth information, and ask for the valid proof of purchase so as to protect your legal rights.

Kirisun and our authorized partners own the intellectual property of all the parts of this product (include accessories). Any design and materials may not be modified, copied, extracted or translated without the authorization of Kirisun or its authorized parities.

Due to the update or modification of the product, Kirisun owns the right to change the specifications of software and hardware described in this manual without further notice. Specifications and information contained in this manual are for reference only.

Kirisun reserves the right to interpret the mistakes and errors occurring in this manual, though all the contents are checked carefully.

**Safety**

Before using this radio, read this operating instruction carefully for safe and convenient usage.

This product can only be maintained by the professional technicians. Do not disassemble the radio by yourself.

To avoid of the problems caused by electromagnetic interference or electromagnetic compatibility, turn off the radio in any facilities

where posted notices instruct you to do so, such as hospital and other health care facilities. And when on board an aircraft, turn off the radio if instructed to do so too.

In the vehicle with an air bag, do not place the radio in the area over an air bag or in the air bag deployment area.

Turn off the radio before entering any area with a potentially explosive atmosphere or blasting caps.

Do not operate the radio, disassemble or charge the battery in the potentially flammable and explosive atmosphere (such as gas station, coal gas station, etc.).

Do not place the radio under the direct sunlight or near the area with heating devices.

Do not place the radio in the area with great dust, moisture or drips, or on the unstable surface.

Contact us or your local dealer for help if you want to re-develop or modify the radio.

Do not use any portable radio that has a damaged antenna. If a damaged antenna comes into contact with your skin, a minor burn can result.

Make sure the antenna is correctly installed when using. The radio without antenna may cause damage in the process of transmission.

Keep the radio vertically and away from your mouth about 5cm in the process of transmission.

When worn on your body, make sure the antenna is at least 2.5cm away from your body in the process of transmission.

**Battery**

All batteries can cause property damage and/or bodily injury, such as burns, if a conductive material such as jewelry, keys, or beaded chains touches exposed terminals. The conductive material may complete an electrical circuit (short circuit) and become quite hot. Excessive care in handling any charged battery, particular when placing it inside a pocket, purse, or other container with metal objects. To reduce the potentially damage, do not expose the battery in the fire, or disassemble and extrude the battery. The maximum ambient temperature around the adapter or transformer for the charger should not exceed 40°C (104°F). Turn off the radio when charging. If not, the battery's capacity will be affected.

Do not insert the battery pack into the charger when charging is not necessary. The continuous charging will shorten the battery's lifetime. Do not use the charger as the pedestal for the radio.

To realize the best performance of the battery, change the battery once a year.

Kirisun Communication Co., Ltd.

## CONTENTS

■ UNPACKING AND CHECKING EQUIPMENT.....	1
■ SUPPLIED ACCESSORIES .....	1
■ PREPARATION.....	2
● CHARGING THE BATTERY PACK ... ..	2
● INSTALLING/REMOVING THE BATTERY PACK.....	3
● INSTALLING THE ANTENNA.....	4
● INSTALLING THE OPTIONAL SPEAKER/MICROPHONE.....	4
● INSTALLING/REMOVING THE BELT CLIP.....	4
■ RADIO OVERVIEW.....	5
■ BASIC OPERATION.....	6
■ SCAN FUNCTION.....	7
● STARTING SCAN.....	7
● STOPPING SCAN.....	7
■ AUXILIARY FUNCTIONS.....	10
● TIME-OUT TIMER.....	10
● BATTERY SAVING.....	10
● LOW BATTERY WARNING.....	10
● MONITOR.....	10
● CTCSS/DCS .....	11
● VOICE ANNUNCIATION OF CURRENT CHANNEL NUMBER..	11
● WIRED CLONE.....	12
● EMERGENCY ALERT.....	13
■ TROUBLESHOOTING GUIDE .....	14
■ SETTINGS .....	15







## ■ UNPACKING AND CHECKING EQUIPMENT

Carefully unpack the radio. We recommend that you identify the items listed in the following table before discarding the packing material. If any damage has occurred during shipment, please contact the dealer immediately.

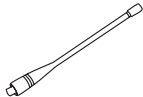
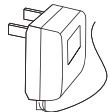
## ■ SUPPLIED ACCESSORIES

ITEM	QUANTITY
Antenna	1
Power adapter	1
Belt clip	1
Charger	1
Hand strap	1
Li-ion battery pack	1
Instruction manual	1

		
Antenna	Power Adapter	Belt clip
		
Charger	Hand Strap	Battery

## ■ PREPARATION

### ● CHARGING THE BATTERY PACK



A new battery or a battery whose power appears low (power indicator displays one bar or no bar) needs charging before using.



Insert the battery or the radio to be charged into the charger slot.

Make sure the battery is in good contact with the charger terminals. When the red indicator lights, the charger begins to charge the battery.

After charging for about 5 hours, the red indicator turns dim and the green indicator lights indicating the battery has been fully charged.

Leave the battery in that state of green indicator for 1~2 hours before you remove it from the charger to achieve the best performance of the battery. Then you can disconnect the power adapter from the AC outlet.

### Notice:

- \* The battery is not fully charged in the factory, and please charge the new battery when you use the radio for the first time.
- \* The radio is supplied with a KB-42A Li-ion battery manufactured by KIRISUN.
- \* When you charge the battery for the first time after purchasing or long storage, you should repeat charging it several times to achieve the normal battery capacity.

\* Do not recharge the battery if it has been fully charged or the battery power doesn't become low, otherwise it might affect the battery life or performance. Remove the battery from the charger after charging.

\* The built-in protection circuit in the battery will cut off power when power appears low. If you charge it in the charger then, the red indicator won't light immediately. About 1~5 minutes later, the charger indicator will become normal.

### ◆ INSTALLING /REMOVING THE BATTERY PACK



#### Installing the Battery Pack

Match the 2 bulges of the battery pack with the corresponding slots at the rear bottom of the radio.

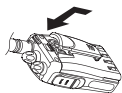

#### Installing the Battery Pack

Then firmly press the battery pack downwards to lock it in place until a click is heard.

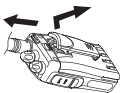

#### Removing the Battery Pack

To remove the battery pack, push the latch upwards and then pull the battery away from the radio.

#### Notice:

- \* Do not short-circuit the battery terminals or dispose exhausted battery in fire.
- \* Do not disassemble the battery casing.

### ◆ INSTALLING THE ANTENNA

Screw the antenna into the connector at the top of the radio by holding the bottom of the antenna and turn it clockwise until secure.



### ◆ INSTALLING THE OPTIONAL SPEAKER /MICROPHONE

Insert the Speaker/Microphone plug into the jacks of the versatile connector.

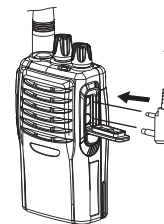

#### Note:

When use the optional Speaker/Microphone, the radio will not be waterproof.

### ◆ INSTALLING /REMOVING THE BELT CLIP

Match the grooves of the belt clip with those on the rear of the battery. Then press the belt clip downwards to lock it in place.

To remove the belt clip, use your nail or a tool to lift the metal spring piece in the belt clip from the topside, and then pull the belt clip away from the radio.

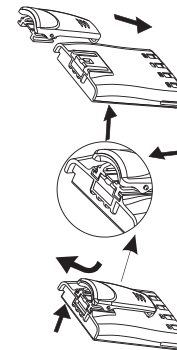

## ■ RADIO OVERVIEW

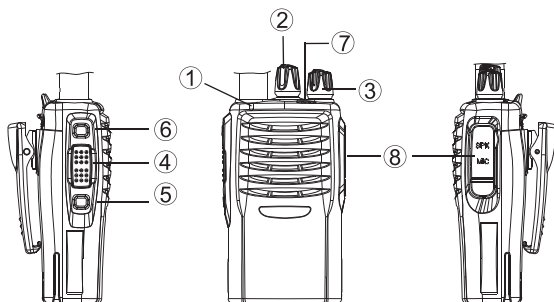

### ① LED Indicator

Lights red when transmitting; lights green when receiving.  
Flashes orange when receiving the identical 5-Tone or 2-Tone signaling.

Flashes red when battery power appears low.

### ② Channel Selector

Rotate to select channel 1~16.

### ③ Power/Volume Knob

Turn clockwise to switch on the radio.

Turn counterclockwise till a click is heard to switch off the radio.

Rotate to adjust the volume after turning on the radio.

### ④ PTT (PUSH-TO-TALK) Button

To make a call, press and hold the PTT button, then speak into the microphone in normal voice. Release the PTT button to receive

signals.

⑤ **Side Button 1** (Programmable Button)

⑥ **Side Button 2** (Programmable Button)

⑦ **Top Button** (Programmable Button)

⑧ **Speaker/Microphone Jacks**

Used to connect the optional speaker/microphone.

## ■ BASIC OPERATION

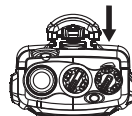

### Switch On

Switch on the radio by turning the Power/Volume switch clockwise till a click is heard, then the radio will be in the state of stand by and you will hear a beep if the dealer has set it. And then you will hear voice annunciation of the current channel number.

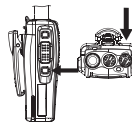

### Adjust Volume

Press the monitor button to listen to the background noise and rotate the Power/Volume switch to adjust volume.

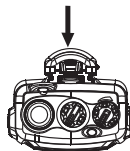

### Select Channels

Rotate the channel selector to select channels.

You will hear voice from the speaker while receiving proper signals.  
If voice annunciation of channel number has been set, the radio will annunciate the current channel number.

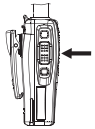

### Make a Call

To make a call, select the desired channel, press and hold the PTT button, and speak in normal voice. Please keep your mouth 3~8 cm away from the microphone.

### Receive a Call

Release the PTT button to receive a call. Select the desired channel, adjust the volume to a proper level, and then you can receive others' voice.

## ■ SCAN FUNCTION

(Your local dealer may prohibit this function.)

Only when there are no less than two channels added in the scan list and the scan function has been activated, the radio can start scanning.



### STARTING SCAN

When switching to channel 16, the radio will begin to scan, and pause after receiving signals.



### STOPPING SCAN

When switching to channel 1-15, the radio will stop scanning.

Introduction:

1. Dealer can set the following two ways to restart scanning after its pause:

- 1) Time-control

The radio will restart scanning after pausing for some time while receiving signals. The pausing time can be preset from 0.5 to 5 seconds.

- 2) Carrier wave control

The radio will pause scanning after receiving signals and will restart scanning 3 seconds after the signal disappears.

2. The working channel of the radio will respond to the following channels automatically when pressing PTT button during scanning. The dealer can select one among the following six ways.

- 1) Last called

When pressing PTT button, the radio will transmit from the last channel that received a call.

- 2) Last used + currently working channel

When pressing PTT button during the scanning, the radio will transmit from the last channel that received a call. When pressing PTT button during the scanning pause, the radio will transmit from the currently working channel.

- 3) Selected channel

When pressing PTT button, the radio will transmit from the first channel of the scanning list.

- 4) Selected channel + currently working channel

When pressing PTT button during scanning, the radio will always transmit from the first channel in the scanning list. When pressing PTT button during the scanning pause, the radio will always transmit from the currently working channel.

- 5) Priority channel

The radio will transmit signals from the priority channel in the scan list when pressing PTT button.

- 6) Priority channel + currently working channel

When pressing PTT button during scanning, the radio will always

transmit from the priority channel. When pressing PTT button during the scanning pause, the radio will transmit from the currently working channel.





**Note:**

\* Currently working channel means the channel in which the radio holds on under the following four conditions.

- 1) After receiving the signals, the radio will still stay in the current channel before restarting the scan.
- 2) When receiving signals during scanning, the radio will pause on the current channel and will keep staying on it for 3 seconds after the signals disappear.
- 3) Radio will stay on the current channel when pressing PTT during scanning.
- 4) When the radio transmitting ends by releasing PTT button, within the transmitting pause time preset by the local dealer, the radio will stay in the current channel.

\* Selected channel: The first channel in the scanning list set by the dealer.

\* Priority channel: The prior channel in the scanning list set by the dealer.

\* Only when priority channel has been selected, the options of  priority channel  and  priority channel + currently working channel  in Revert Channel are available.

## ■ AUXILIARY FUNCTIONS

### ● TIME-OUT TIMER

Time-out timer can prevent the user from continuously talking overlong and prevent the radio body heating due to continuous longtime transmitting.

If you continuously transmit longer than the time limit preset by the dealer, the radio will stop transmitting and warning tone sounds, and to stop the warning tone please release the PTT button. Pressing the PTT button again will resume transmitting.

### ● BATTERY SAVING

The automatic battery saving function decreases the power consumption when no signal is received and no operation is conducted.

If the battery saving function is activated, 10 seconds after the radio doesn't receive any signals or no operation is being conducted, the radio enters battery saving mode. When a signal is received or any operation occurs, it exits battery saving mode automatically.

### ● LOW BATTERY WARNING

When the battery power goes below a certain value in transmitting, LED flashes red and Low battery warning tone sounds and then the radio stop transmitting. You need to recharge or change the battery.

### ● MONITOR

**Off:** When this function is selected, no operation is performed.

**Monitor Momentary:** Press and hold the monitor button to deactivate the signaling temporarily, and squelch un-mutes. Release it to return to normal operation and squelch mutes.

**Monitor Lock:** Press the monitor button once to deactivate the signaling, and squelch un-mutes. Press it again to return to normal operation and squelch mutes.

**SQ Off:** When there is no signal received, the squelch circuit of the radio will automatically mute the speaker, so you will not hear the background noise. Press the MONI key to force the squelch un-mute.

#### ● CTCSS/DCS

CTCSS/DCS tones may have been pre-programmed on some channels. A CTCSS/DCS tone is a sub-audible tone, which allows you to ignore (not hear) calls from other parties who are using the same channel. The dealer can set CTCSS/DCS tones on radio channels.

When you receive a signal that has a tone different from the one set on your radio, you will not hear the signal. Likewise, signals that you transmit will only be received by the parties whose CTCSS/DCS tones are the same as yours.

#### **Note:**

Using a CTCSS/DCS channel doesn't mean your calls are private. If other parties' CTCSS/DCS tones are identical with yours, they can hear your calls.

#### ● Voice Annunciation of Current Channel Number

If voice annunciation of current channel number has been activated, when pressing the channel annunciation button in stand-by mode, the current channel number will be annunciated in the preset language through the loudspeaker. If turn on the radio with this button pressed, the annunciation language will be changed. Repeat turning on the power with this button pressed, the type of the annunciation language can be changed in sequence “ Chinese Male---English Male---Chinese Female---English Female---No Annunciation” .

#### ● Wired Clone

If wire clone function has been activated, after entering wire clone mode, the radio will not exit the wire clone mode automatically. You have to turn on the radio again to enter the user mode. The operating procedure is as follows:

- 1) Press MONI key to turn on the radio. About two seconds later the red light flashes twice and two beeps sound, and then the radio enters the wire clone mode.
- 2) Press PTT button, and slave radio that is to be sent with cloning data will be in the Open/Prohibition wire clone mode. However, the wire clone setting on the master radio will not change. Press PTT button. If the green light flashes twice and one beep sounds it is in the Open state; if the red light flashes twice and two beeps sound it is in the Prohibition state. When entering wire clone mode, the default setting on the slave cloned radio is wire clone prohibition.
- 3) Press MONI key, the red light flashes and cloning begins. When cloning is finished, red light turns dim.

#### **Note:**

You can open or prohibit the wire clone mode by PC programming software.

Once the wire clone function is prohibited, the radio cannot enter wire clone mode. Wire clone prohibition is set as the default when the radio leaves factory.

#### ● Emergency Alert

Press the emergency button for more than 2 seconds, and then the radio enters the state of emergency alert: red light flashes, and loud

warming tone sounds.

Press the emergency button again to exit the emergency state.

In emergency state, any other keys or buttons are inactive.

## ■ TROUBLE SHOOTING GUIDE

NO.	PROBLEM	SOLUTION
1	The radio cannot be switched on or no display after being switched on.	<ul style="list-style-type: none"> <li>• Battery power may be insufficient. Recharge or replace the battery pack.</li> <li>• Battery pack may not be installed properly. Remove the battery pack and install it again.</li> </ul>
2	The battery power consumes quickly after charging.	<ul style="list-style-type: none"> <li>• The battery life is finished; please replace it with a new battery pack.</li> </ul>
3	Cannot talk to or hear other group members .	<ul style="list-style-type: none"> <li>• Make sure the CTCSS/DCS tone is the same as that of your group members.</li> <li>• Out of the effective communication range.</li> </ul>
4	Other voices from non-group members are heard on the Channel.	<ul style="list-style-type: none"> <li>• Change the CTCSS/DCS tone, and make sure to changed the tone of all radios in your group.</li> </ul>
5	Communication range is too short.	<ul style="list-style-type: none"> <li>• Make sure the antenna is well connected.</li> <li>• Make sure the antenna is the original one.</li> <li>• Check if the battery power is in normal state.</li> <li>• Ask your local dealer to adjust the squelch level.</li> </ul>

## ■ SETTINGS (set by the dealer)

Model: \_\_\_\_\_

Serial No.: \_\_\_\_\_

### 1) Channels List

CHANNEL	TRANSMITTING FREQUENCY	RECEIVING FREQUENCY	CTCSS/DCS
1			
2			
3			
4			
5			
6			
7			
8			
9			
10			
11			
12			
13			
14			
15			
16			

### 2) The way to restart scanning after its pause:

Time control

Carrier wave control

### 3) The way to revert the working channel:

Selected channel

Selected channel or currently working channel

Priority channel

Priority channel or currently working channel

### 4) Squelch monitor:

Open

Close

### 5) Time-out timer:

Open

Close

### 6) Automatic scan:

Open

Close